

Signet 9900 Transmitter



Member of the SmartPro® Family of Instruments



Panel Mount

Field Mount

The Signet 9900 Transmitter provides a single channel interface for many different parameters including Flow, pH/ORP, Conductivity/Resistivity, Salinity, Pressure, Temperature, Level, Dissolved Oxygen, and other sensors that output a 4 to 20 mA signal. The 9900-1P Transmitter can also be used as a Batch Controller when a Batch Module and Relay Module are installed.

The 9900 is offered in both panel or field mount versions. Both configurations offer an extra large (3.90" x 3.90") auto-sensing backlit display features "at-a-glance" visibility that can be viewed at 4-5 times the distance over traditional transmitters. The highly illuminated display and large characters reduce the risk of misreading or misinterpreting the displayed values. The display shows separate lines for units, main and secondary measurements as well as a "dial-type" digital bar graph.

The 9900 can run on 12 to 32 VDC power (24 VDC nominal), and can also be loop powered with compatible sensors.

Rear Enclosure kits are available for the 9900-1P Panel Mount. Kit options include either a Hinged Cover (3-9900.399-1) for wall or pipe mount installations, or a Flat Cover (3-9900.399-2) designed to fit inside a panel for waterproof protection.

The 9900 offers complete flexibility, plug-in modules allow the unit to easily adapt to meet changing customer needs. Optional modules include the new Modbus as well as the Relay, Direct Conductivity/Resistivity, H COMM, Batch, 4 to 20 mA Output, and a PC COMM Configuration Tool. The unit can be used with default values for quick and easy programming or can be customized with labeling, adjustable minimum and maximum dial settings, and unit of measure and decimal location choices.

Features

- Modbus Module supports RS485 Serial Modbus Communications
- Multiple sensor types supported with one instrument
- "Dial-type" digital bar graph
- Modules are field installable and replaceable anytime
- Optional Relay Module for addition of two dry contact relays
- Optional H COMM Module for two-way communication
- Optional Batch Module for Batch Control
- Modbus Module for connection to Serial, RS485, Modbus networks
- One 4 to 20 mA output in base unit. One additional 4 to 20 mA available with optional module
- Rear Enclosure kits for panel, wall or pipe mounting
- Warning and Relay LED indicators for "at a glance" visibility
- Customizable features including digital label for custom identification
- Optional PC COMM configuration tool for configuration at a PC



Applications

- Wastewater Treatment
- Reverse Osmosis
- Deionization
 - Ultra Pure Water
 - Two Bed System
 - Mixed Bed System
- Chemical Manufacturing/Addition
- Metal and Plastic Finishing
- Fume Scrubber
- Cooling Towers
- Media Filtration

Specifications

General			
Input Channels		One	
Input Types	Digital (S ³ L)	Serial ASCII, TTL level, 9600 bps	
	Frequency	Range	0.5 to 1500 Hz
		Accuracy	0.5% of reading
Measurement Types		Flow, pH/ORP, Conductivity/Resistivity, Salinity, Pressure, Temperature, Level, Dissolved Oxygen, Batch or user-defined (via 8058)	
Enclosure and Display			
Case Material		PBT	
Window		Shatter-resistant glass	
Keypad		4 buttons, injection-molded silicone rubber seal	
Display		Backlit, 7 and 14-segment	
Update Rate		1 s	
LCD Contrast		5 settings	
Indicators		"Dial-type" digital bar graph. LEDs for Open Collector, Relays and Warning Indicator	
Enclosure Size		¼ DIN	
Mounting	9900-1P		
	Panel	¼ DIN, ribbed on four sides for panel mounting clip inside panel, silicon gasket included. Optional rear enclosure with flat cover available for waterproof protection when installed inside a panel.	
	Wall	Options include 9900-1P installed in pre-wired NEMA enclosure, wall mount enclosure or inside of rear enclosure with hinged cover. (USA Only)	
	Pipe	Optional Rear Enclosure with hinged cover and 9900-1P for pipe mount installation	
Mounting	9900-1		
	Field (Integral)	Options include yellow universal or integral kits for installation with sensor	
Display Ranges			
pH		0.00 to 15.00 pH	
pH Temperature		-39.99 °C to 149.99 °C	-40 °F to 302 °F
ORP		-1999 to +1999 mV	
Flow Rate		-9999 to 99999 units per second, minute, hour or day	
Totalizer		0.00 to 99999999 units	
Conductivity		0.0000 to 99999 µS, mS, PPM and PPB (TDS), kΩ, MΩ	
Conductivity Temperature		-100 °C to 250 °C	-148 °F to 350 °F (application and sensor dependent)
Temperature		-99 °C to 350 °C	-99 °F to 350 °F
Pressure		-40 to 1000 psi	
Level		-9999 to 99999 m, cm, ft, in, %	
Volume		0 to 99999 cm ³ , m ³ , in ³ , ft ³ , gal, L, lb, kg, %	
Salinity		0 to 99.97 PPT	
Dissolved Oxygen		PPM 0-50, % SAT 0-200, 0 to 999.9 TORR	
Dissolved Oxygen Temperature		-99 °C to 350 °C	-99 °F to 350 °F
Environmental			
Ambient Operating Temperature			
Backlit LCD		-10 °C to 70 °C	14 °F to 158 °F
Storage Temperature		-15 °C to 70 °C	5 °F to 158 °F
Relative Humidity		0 to 100% condensing for field mount; 0 to 95% non-condensing for panel mount	
Maximum Altitude		4,000 m (13,123 ft)	
Enclosure Rating		NEMA 4X/IP65 (front face only on panel mount); field mount is 100% NEMA 4X/IP65 when used with universal or integral installation kits	

Specifications (continued)

Electrical Requirements

Power to Sensors

Voltage	+4.9 to 5.5 VDC @ 25 °C, regulated	
Current	1.5 mA max in loop power mode (up to 2.0 mA with 24 V @ 300 Ω max. loop impedance); 20 mA max when using DC power	
Short Circuit	Protected	
Isolation	Low voltage (< 48V AC/DC) to loop with DC power connected	
No isolation when using loop power only		
Terminal Blocks	Pluggable screw type	14 AWG max wire gauge

Input Power

DC	10.8 to 35.2 VDC, regulated	
9900 without Relay Module	200 mA @ 10.8 VDC to 35.2 VDC	
9900 with Relay Module	300 mA @ 10.8 VDC to 35.2 VDC	
Oversvoltage Protection	48 Volt Transient Protection Device	

Current limiting for circuit protection

Reverse-Voltage Protection

Loop Power

Loop Power Only

	Max. Loop Impedance	50 Ω @ 12 V	325 Ω @ 18 V	600 Ω @ 24 V
--	---------------------	-------------	--------------	--------------

With DC Power Input or with 2nd loop, all the time

	Max. Loop Impedance	250 Ω @ 12 V	500 Ω @ 18 V	750 Ω @ 24 V
--	---------------------	--------------	--------------	--------------

Relay Specifications

	Dry-Contact Relays (2)	Open Collector (1)
Type	SPDT	N/A
Form	C	N/A
Max. Current Rating	5 A resistive	50 mA DC
Max. Voltage Rating	30 VDC or 250 VAC	30 VDC
Hysteresis	Adjustable (absolute in engineering units) (EUs)	
Latch	Reset in test screen only	
Delay	9999.9 seconds (max.)	
Test Mode	Set On or Off	
Cycle Time	99999 seconds (max.)	
Maximum Pulse Rate	300 pulses/minute	
Proportional Pulse	400 pulses/minute	
Volumetric Pulse Width	0.1 to 3200 s	
Pulse Width Modulation	0.1 to 320 s	

Input Types

Digital (S³L) or AC frequency

4 to 20 mA input via the 8058-1

pH/ORP input via the Digital (S³L) output from the 2750/2751 pH/ORP Sensor Electronics

Raw Conductivity/Resistivity input directly from Signet Conductivity/Resistivity electrodes via Direct Conductivity/Resistivity Module or via 2850

Input Specifications

Digital (S ³ L)	Serial ACSII, TTL level, 9600 bps
----------------------------	-----------------------------------

Frequency Input

Sensitivity	80 mV @ 5 Hz, gradually increasing with frequency
Span	0.5 Hz to 1500 Hz @ TTL level input
Accuracy	± 0.5% or reading max error @ 25 °C
Resolution	1 μS
Repeatability	± 0.2% of reading

Specifications (continued)

Input Specifications continued

Power Supply

Rejection	±1 µA per volt
Short Circuit	Protected

Update Rate	(1/frequency) + 150 ms
-------------	------------------------

Direct Conductivity/Resistivity Module (3-9900.394)

Accuracy	Conductivity +/- 2% of Reading
	Temperature 0.5 °C
Resolution	Conductivity 0.1% of Reading
	Temperature <0.2 °C
Update Rate	2.5 Seconds
Compatible Electrodes	All GF Signet Sensors

Output Specifications

Current Output - One (1); Two (2) with 4 to 20 mA Output Module

Current Loop Output Standard	ANSI-ISA 50.00.01 Class H		
Current Output	4 to 20 mA, isolated, fully adjustable and reversible		
Span	3.8 to 21 mA		
Zero	4.0 mA factory set; user programmable from 3.8 to 5.0 mA		
Full Scale	20.00 mA factory set; user programmable from 19.0 to 21.0 mA		
Accuracy	±32 µA max. error @ 25 °C @ 24 VDC		
Resolution	6 µA or better		
Temperature Drift	±1 µA per °C		
Power Supply Rejection	±1 µA per V		
Isolation	Low voltage (< 48 VAC/DC)		
Voltage	12 to 32 VDC ±10%		
Max. Impedance (with DC power input)	250 Ω @ 12 VDC	500 Ω @ 18 VDC	750 Ω @ 24 VDC
Max. Impedance (no DC power input)	50 Ω @ 12 VDC	325 Ω @ 18 VDC	600 Ω @ 24 VDC
Update Rate	150 mS nominal		
Short circuit and reverse polarity protected			
Adjustable Span	Reversible		
Error Condition	Selectable error condition 3.6 or 22 mA		
Actual update rate determined by sensor type			
Test Mode	Increment to desired current (range 3.8 to 21.00 mA)		

Shipping Weights

Base Unit	0.63 kg	1.38 lb
Modbus Module	0.16 kg	0.35 lb
H COMM Module	0.16 kg	0.35 lb
Conductivity Module	0.16 kg	0.35 lb
Relay Module	0.19 kg	0.41 lb
Batch Module	0.16 kg	0.35 lb
4 to 20 Output Module	0.16 kg	0.35 lb
Rear Enclosure, Hinged cover	0.30 kg	0.65 lb
Rear Enclosure, Flat cover	0.28 kg	0.60 lb

Standards and Approvals

CE, UL, CUL, FCC
RoHS Compliant, China RoHS
Lloyd's Register
Manufactured under ISO 9001 and ISO 14001 for Environmental Management and OHSAS 18001 for Occupational Health and Safety

Dimensions - Panel Mount

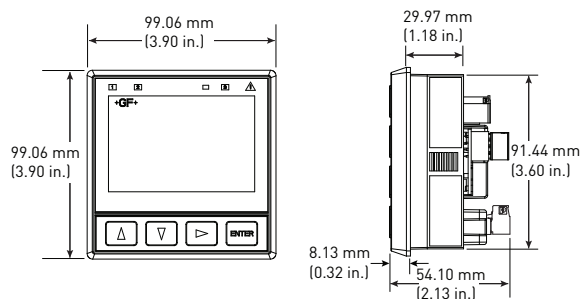

Dimensions - Rear Enclosure

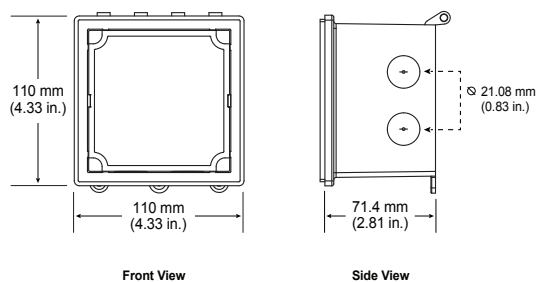

Integral Mount

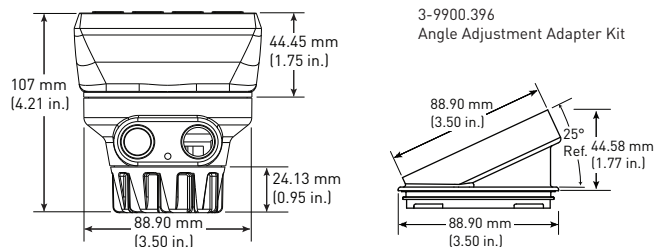

Hinged Cover

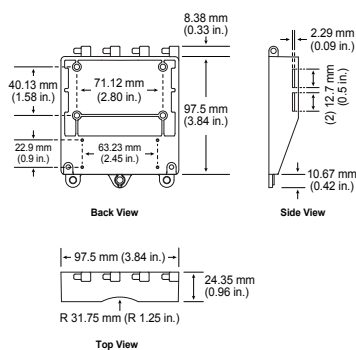

Flat Cover

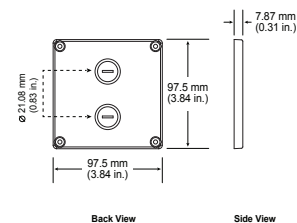





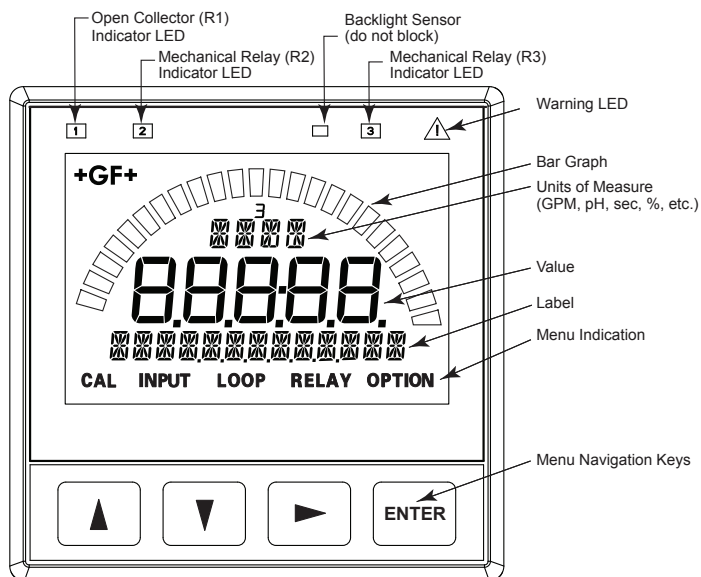





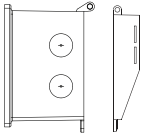





















Sensor model	9900 Generation			
	I	II	III	IV
515/8510	X	X	X	X
525	X	X	X	X
U1000				X
2000	X	X	X	X
2100	X	X	X	X
2250	X	X	X	X
2350	X	X	X	X
2450	X	X	X	X
2507	X	X	X	X
2536/8512	X	X	X	X
2537-5	X	X	X	X
2540	X	X	X	X
2551	X	X	X	X
2552	X	X	X	X
2610-51	X	X	X	X
2610 + 8058	X	X	X	X
2724-2726	X	X	X	X
2734-2736	X	X	X	X
2750	X	X	X	X
2751	X	X	X	X
2756-2757	X	X	X	X
2764-2767	X	X	X	X
2774-2777	X	X	X	X
2819-2823	X	X	X	X
2839-2842	X	X	X	X
2850	X	X	X	X
4150 + 8058	X	X	X	X





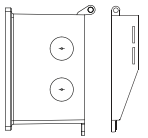

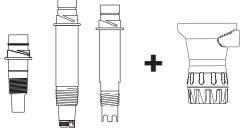
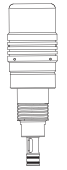
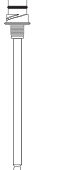
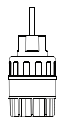

9900 Module	9900 Generation			
	I	II	III	IV
H COMM	X	X	X	X
Relay	X	X	X	X
Conductivity/Resistivity	X	X	X	X
Batch		X	X	X
4 to 20 mA Output			X	X
Modbus	X	X	X	X

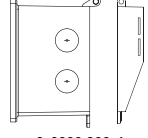

All possible segments shown in this illustration. The instrument's software controls which segments are shown at any particular time. Only the bar graph segment outline and GF logo are visible when the unit is turned off.

Panel Mount	Pipe, Tank, Wall Mount	Field (Integral) Mount
Signet Model 9900 Transmitter (Includes mounting bracket and panel gasket) 	Signet Model 9900 Transmitter with Rear Enclosure   3-9900.399-1	Signet Model 9900 Transmitter with Junction Box (varies with sensor and installation)     
Signet Sensors - Flow, Level, Temperature, Pressure, DO Use one input from sensor options below*                		2270 with 8058 iGo Converter plus other 4 to 20 mA  
Signet Fittings - See individual sensor data sheets		All sold separately

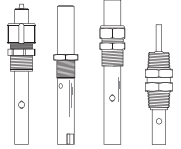
Panel Mount	Pipe, Tank, Wall Mount	Field (Integral) Mount
Signet Model 9900 Transmitter (Includes mounting bracket and panel gasket) 	Signet Model 9900 Transmitter with Rear Enclosure   3-9900.399-1	Signet Model 9900 Transmitter with Junction Box (varies with sensor and installation)    
Signet Sensors - pH/ORP Use one input from sensor options below* with 2751 Smart Sensor Electronics 		Signet Wet-Tap Electrode Model 2756, 2757 and 3719 Wet-Tap with 2751 Smart Sensor Electronics   
Signet Fittings - See individual sensor data sheets		All sold separately

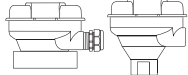
Panel Mount	Pipe, Tank, Wall Mount	Field (Integral) Mount
Signet Model 9900 Transmitter (Includes mounting bracket and panel gasket) 	Signet Model 9900 Transmitter with Rear Enclosure   3-9900.399-1	Signet Model 9900 Transmitter with 3-9900.396 Angle Adapter and Junction Box (varies with sensor and installation)    
Signet Sensors - Conductivity/Resistivity and Salinity Electrodes Use one input from electrode options below* with Conductivity Module or 2850 Sensor Electronics   OR 		
Signet Fittings - See individual sensor data sheets		All sold separately

* See individual sensor datasheets for additional information

**3-9900.396 is required with the Conductivity Module and either 3-8050 or 3-8052 to provide sufficient clearance

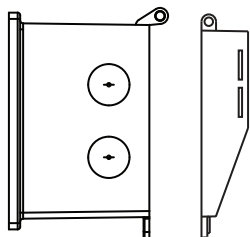

3-9900.399-1
(159 001 834)
Rear Enclosure Kit,
hinged cover



3-9900.399-2
(159 001 835)
Rear Enclosure Kit,
flat cover

3-9900-1
(159 001 696)
Field Mount

3-9900-396
(159 001 701)
Angle Adjustment
Adapter Kit

3-8051 (159 000 187)
3-8051-1 (159 001 755)
3-8051-2 (159 001 756)
Flow Sensor
Integral Mounting Kit

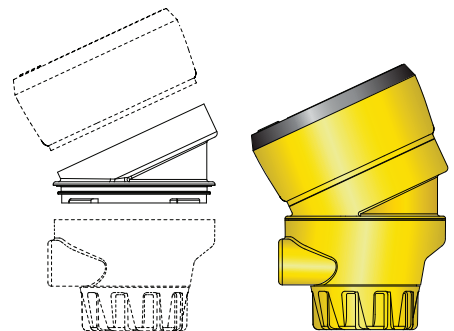

Plug in Modules

Optional modules and accessories are available for the 9900:

- Base Unit (required)
- Slot for optional H COMM or Modbus Modules
- Slot for optional Conductivity/Resistivity, Batch, or 4 to 20 mA Output Module
- Slot for optional Relay Module (not available on field mount)

Each item is ordered separately.

Modules are field-replaceable at any time.

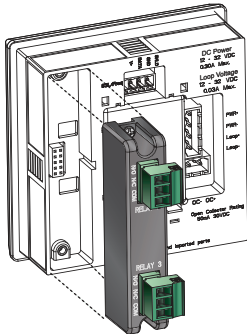
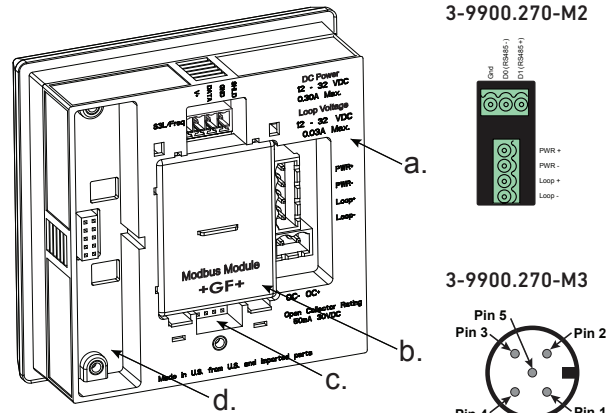

Relay Module (Panel Installations Only) (3-9900.393)

This module adds two programmable dry-contact relays to the standard Open Collector output in the base unit.

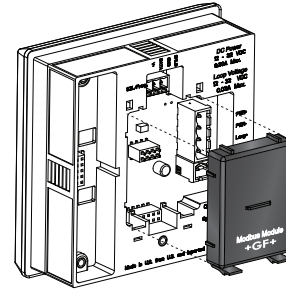

Modbus Modules (3-9900.270-MX)

These Modules allow the 9900 to communicate with Automation systems using the Modbus serial RS485 Protocol.
 3-9900.270-M2 - Terminal Block Connections (Panel Mount Only)
 3-9900.270-M3 - M12 Connector (Field Mount Only)
 3-9900.270-M4 - Modbus Module with 5 Wire Cable Assembly

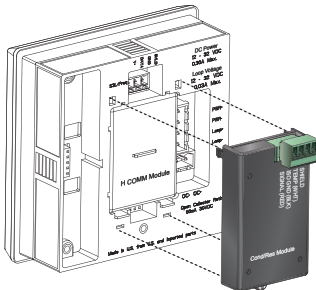

Direct Conductivity/Resistivity Module (3-9900.394)

The Direct Conductivity/Resistivity Module interfaces Signet 2819-2823 and 2839-2842 Conductivity electrodes directly to the 9900.

H COMM Module (HART®) (3-9900.395)

The H COMM Module enables communication between the 9900 and a HART® enabled device.
 (Not available for use on 3-9900-1BC Batch Controller)

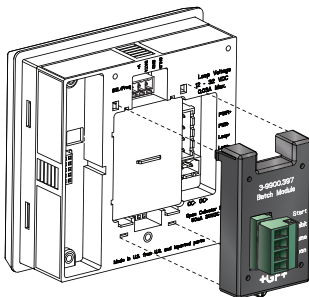

Batch Module (3-9900.397)

The Batch Module adds batch capability to the 9900 Transmitter (Generation II and newer). It is compatible with all Signet flow sensors.

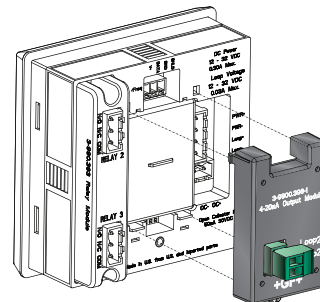

4 to 20 mA Output Module (3-9900.398-1)

The 4 to 20 mA Output Module adds a second 4 to 20 mA Output to the 9900 Transmitter (Generation III and later). Each of the outputs can be used to output the primary and/or secondary measurement.

Ordering Information

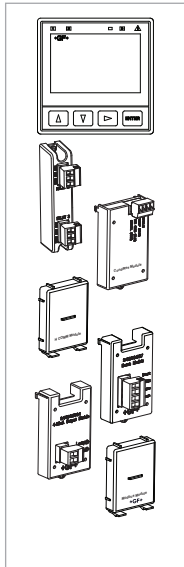

Mfr. Part No	Code	Description
9900 Base Unit - Single Channel, Multi-Parameter, 4 to 20 mA, Open Collector, DC power		
3-9900-1P	159 001 695	9900 Panel Mount Transmitter
3-9900-1	159 001 696	9900 Field Mount Transmitter
3-9900-1BC	159 001 770	Batch Controller System
Optional Accessory Modules		
3-9900.270-M2	159 200 121	Modbus Module with Terminal Block Assembly (Panel Mount Only)
3-9900.270-M3	159 200 122	Modbus Module with M12 Connector Assembly (Field Mount Only)
3-9900.270-M4	159 200 128	Modbus Module with 5 Wire Cable Assembly
3-9900.393	159 001 698	Relay Module - 2 DCR (Dry-contact relays)
3-9900.394	159 001 699	Direct Conductivity/Resistivity Module
3-9900.395	159 001 697	H COMM Module
3-9900.397	159 310 163	Batch Module
3-9900.398-1	159 001 784	4 to 20 mA Output Module*

*Module adds a second 4 to 20 mA output. One 4 to 20 mA output is included in the base unit.

Accessories and Replacement Parts

Mfr. Part No	Code	Description
6682-0204	159 001 709	Conductivity Module Plug, 4 Pos, Right Angle
6682-1102	159 001 710	DC Power Plug, 2 Pos, Right Angle
6682-1103	159 001 711	Relay Module Plug, 3 Pos, Right Angle
6682-1104	159 001 712	Loop Power Plug, 4 Pos, Right Angle
6682-3104	159 001 713	Freq/S ³ L Plug, 4 Pos, Right Angle
6682-3004	159 001 725	Terminal Block Plug
7310-1024	159 873 004	24 VDC Power Supply, 0.42 A, 10W
7310-2024	159 873 005	24 VDC Power Supply, 1.0 A, 24W
7310-4024	159 873 006	24 VDC Power Supply, 1.7 A, 40W
7310-6024	159 873 007	24 VDC Power Supply, 2.5 A, 60W
7310-7024	159 873 008	24 VDC Power Supply, 4.0 A, 96W
3-0252	159 001 808	0252 Configuration Tool
3-8050	159 000 184	Universal Mount Kit
3-8050.396	159 000 617	RC Filter kit (for relay use), 2 per kit
3-8051	159 000 187	Flow Sensor Integral Mounting Kit, NPT, Valox
3-8051-1	159 001 755	Flow Sensor Integral Mounting Kit, NPT, PP
3-8051-2	159 001 756	Flow Sensor Integral Mounting Kit, NPT, PVDF
3-8052	159 000 188	¾ in. Integral Mount Kit
3-8058-1	159 000 966	I-Go® Signal Converter, wire-mount
3-8058-2	159 000 967	I-Go® Signal Converter, DIN rail mount
3-9000.392-1	159 000 839	Liquid Tight Connector Kit, NPT (1 pc.)
3-9900.270-CB1	159 200 123	Replacement Wire Cable Assembly for M1
3-9900.270-CB2	159 200 124	Replacement Terminal Block Assembly for M2
3-9900.270-CB3	159 200 125	Replacement M12 Connector Assembly for M3
3-9900.270-CB4	159 200 129	Replacement Cable Assembly for M4
3-9900.390	159 001 714	Standard Connector Kit, Right Angle, 9900 Transmitter
5541-5005	159 855 021	5 meter (16 ft) M12 cable
5541-5010	159 855 022	10 meter (32 ft) M12 cable
3-9900.391	159 001 715	Optional Connector Kit, In-Line, 9900 Transmitter
3-9900.392	159 001 700	Wall Mount Accessory Kit for 9900
3-9900.396	159 001 701	Angle Adjustment Adapter Kit (for Field Mounting)
3-9900.399-1	159 001 834	Rear enclosure kit, hinged cover
3-9900.399-2	159 001 835	Rear enclosure kit, flat cover

3-9900.099 Rev P (02/19)

© Georg Fischer Signet LLC

3401 Aero Jet Avenue, El Monte, CA 91731-2882 U.S.A. • Tel. (626) 571-2770 • Fax (626) 573-2057 • www.gfsignet.com • e-mail: signet.ps@georgfischer.com
 Specifications subject to change without notice. All rights reserved. All corporate names and trademarks stated herein are the property of their respective companies.